

## Quick Start Guide

### High-Temperature Furnace

LHT 02/16 - LHT 08/18  
LHT 01/17D - LHT 03/17D

M01.1079K ENGLISCH

Original instructions

■ Made  
■ in  
■ Germany

[www.nabertherm.com](http://www.nabertherm.com)

---

### **Copyright**

© Copyright by  
Nabertherm GmbH  
Bahnhofstrasse 20  
28865 Lilienthal  
Federal Republic of Germany

Reg: M01.1079K ENGLISCH  
Rev: 2023-06

No responsibility is accepted for the correctness of this information. We reserve the right to make technical alterations.

## 1 Important

This operating instructions summary is a shortened version of the full operating instructions to give you an initial orientation. Read the operating instructions completely before initial start-up.

You can obtain the operating instructions for the kiln via the following link or by scanning this QR code: Apps to scan QR codes can be downloaded from the corresponding sources (app stores).



<https://nabertherm.com/en/downloads/instructions>

Keep a printed or stored version for later use. You may also request a printed version of the operating instructions. Contact us, stating the kiln model and serial number (see typeplate).

## 2 More information and tutorials



<https://nabertherm.com/en/downloads/video-tutorials>

These documents are intended only for buyers of our products and may not be copied or disclosed to third parties without our written consent.

(Law governing copyright and associated protective rights, German Copyright Law from Sept. 9, 1965)

Nabertherm GmbH owns all rights to drawings, other documents and authorizations, also in case of applications for protective rights.

## 3 Defined Application

Furnaces in this series are designed especially to sinter ceramic materials in a normal air atmosphere. The system must not be operated with explosive gases or mixtures and it must be ensured that explosive gases or mixtures do not form during the process.









If substances are introduced into the furnace that form health-endangering compounds as a result of thermal decomposition, the operator must take special measures, including precautions to detect hazards at the installation location, protective equipment for operators, measures to reduce exhaust emissions. The service life of the heating elements will be reduced if the furnace is operated regularly at low temperatures below 1300°C and also with regular operation at temperatures close to the maximum temperature. The maximum temperature of the furnace is shown on the type plate.

LHT 02/16 - LHT 08/18 furnaces are designed for many different uses in research and in laboratories, especially for sintering oxide ceramics.

The LHT 01/17D and LHT 03/17D models are ideal for sintering translucent and non-translucent zirconium oxide, for example bridges and crowns. The special heating elements in these furnaces provide very good protection against chemical interactions between the charge and the furnace components. Use of staining solutions can lead to disproportionate wear of the heating elements. If these are used, make sure that they are dried well beforehand to minimize effects on the heating elements.

## 4 Safety precautions

Below is a list of safety precautions in the highest danger level, which, if not observed, may result in serious personal injury. A complete overview of all safety precautions can be found in the kiln operating instructions. Please read the operating instructions before initial start-up and use.

 	<p><b>Danger of electric shock</b>  <b>Risk of fatal injury</b></p> <p>Work on the electrical equipment may be performed only by qualified electricians or by specialists authorized by Nabertherm.</p> <p>Before starting work, disconnect the plug</p> <p>The device must not get wet</p> <p>Do not insert objects into openings in the kiln housing, exhaust holes or cooling slits of the switchgear or kiln.</p>
	<p><b>Risk of fire, danger to health</b>  <b>Risk of fatal injury</b></p> <p>Observe the installation conditions</p> <p>Adequate ventilation must be ensured at the installation location to remove exhaust heat and exhaust gases.</p>
	<p><b>Do not open when hot</b></p> <p>Opening the kiln when it is hot <b>above 200 °C (392 °F)</b> can cause burns.</p> <p>No liability is assumed for damage to ware or kiln.</p>
 	<p><b>For all kiln systems</b></p> <p>These kiln systems have no safety technology for processes in which flammable mixtures can form</p> <p>Operation with explosive gases or mixtures or the formation of explosive gases or mixtures during the process is not permitted.</p> <p>Do NOT place any potentially explosive dusts or solvent mixtures inside the device.</p> <p>Do NOT operate the device in areas where there is a risk of explosion.</p>
	<p><b>Bypass connection/exhaust duct, lid and kiln housing are hot when the kiln is in operation.</b></p> <p><b>Risk of burning.</b></p> <p>Bypass connection/exhaust duct, lid and housing must NOT be touched during operation.</p>
	<p><b>Risk of fire if using an extension cable</b>  <b>Risk of fatal injury</b></p> <p>For all kiln models with a plug-in connection, ensure that the distance between the circuit breaker and the power socket to which the kiln is connected is as short as possible.</p> <p>NO power board or extension cable is used between the power socket and the kiln.</p>

## 5 System components

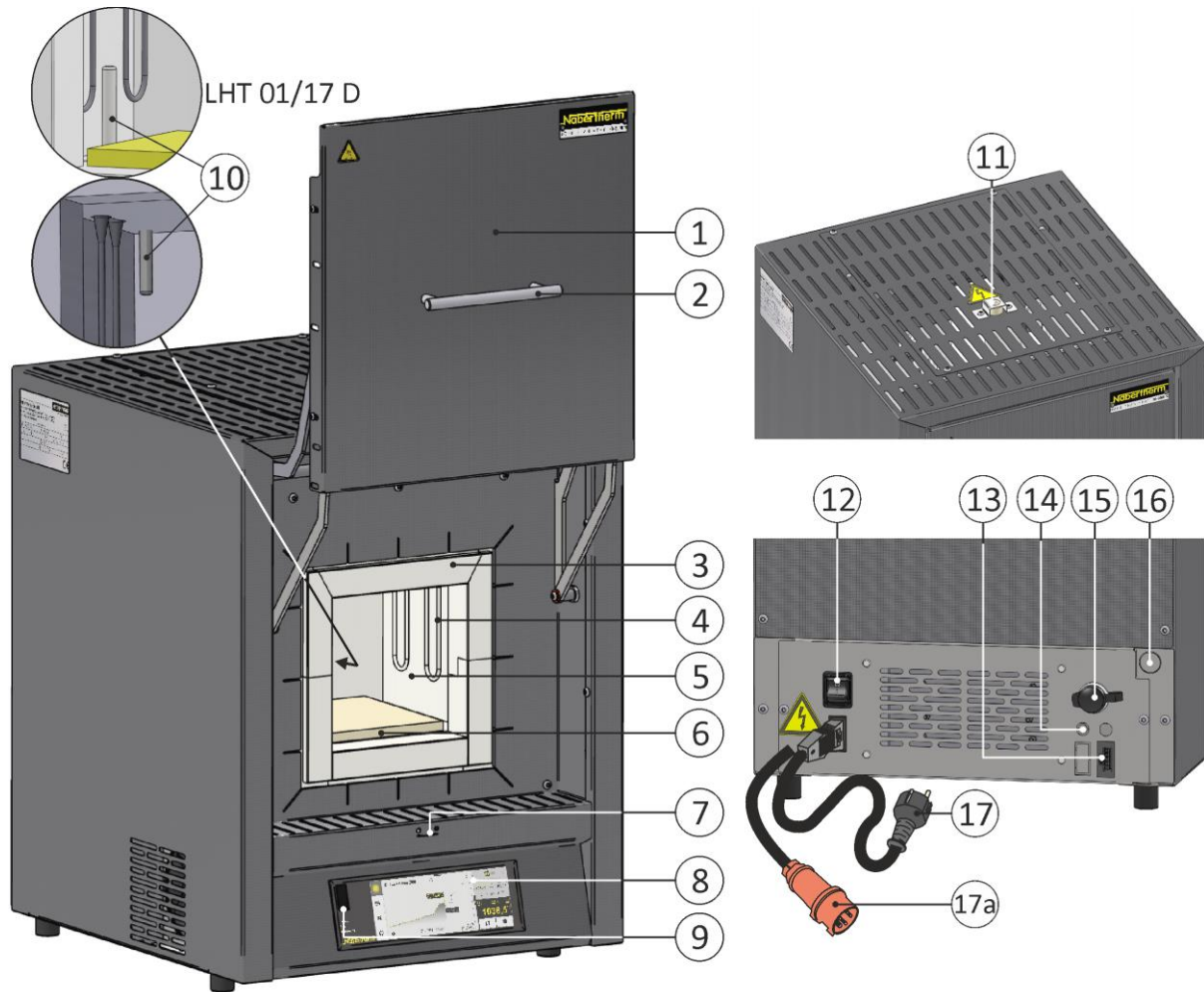

No.	Name	No.	Name
1	Lift door	10	Thermocouple
2	Handle	11	Exhaust air tube
3	Insulation made from non-classified fiber material	12	Power switch with integrated fuse (for switching furnace on/off)
4	Heating elements made from molybdenum disilicide ( $\text{MoSi}_2$ )	13	Additional power connection (for accessories)
5	Furnace chamber	14	Fuse for additional power connection (for accessories)
6	Floor plate	15	Ethernet interface (additional equipment)
7	Fresh-air flap to control fresh air	16	Protective gas connection (additional equipment)
8	Controller series B510/C550/P580	17	Power plug (to 3600 watts) with snap-in coupling
9	USB interface	17a	CEE plug (from 3600 watts, max. 32 A)

## 6 Transporting the furnace



### Note

Wear protective gloves when installing the furnace.  
The furnace should be transported by at least two people.

- When the furnace is delivered, check the transport packaging for possible damage. Remove straps from the transportation packaging.
- Compare the delivered items with the delivery note and the purchase order documents.
- Carefully lift the cardboard box. On the pallet, you will find a packaging unit for accessories (e.g., exhaust air duct, tile, power cable).
- To carry the furnace, place your hands at the sides beneath it and make sure that you have a firm grip. Lift the furnace from the pallet and carefully lower it at the location where it is to be installed.
- The packaging material inside and around the furnace must be removed completely. All packaging material can be recycled.

## 7 Requirements for the installation location

Install the furnace only in a dry room. Temperatures should be between +5 °C and +40 °C, with maximum 80% humidity. The surface (floor or bench) where the furnace is to be installed must be level so that the furnace stands upright. Place the furnace on a non-flammable surface. The load-bearing capacity of the bench must be suitable to take the weight of the furnace plus accessories.

Flammable materials must be kept at least 0.5 m from the furnace on all sides and at least 1 m above the furnace. In some cases, the distance must be greater due to local conditions. The minimum distance between the furnace and non-flammable materials may be reduced to 0.2 m at the sides. If the charge emits gases or vapors, ensure adequate ventilation at the installation site and/or a suitable exhaust gas venting system. The customer must provide a suitable extractor for exhaust air.

## 8 Assembly, Installation, and Connection

### Installing the insulation block and the exhaust air tube

To prevent damage, the exhaust air tube and the associated insulation block are delivered in a separate packaging unit. Both components must be installed before operating the furnace. **The furnace must not be operated before this is done.**

To install the insulation block, undo the screws from the top furnace cover (1), remove the cover and position one of the drilled holes of the block above the hole of the inner insulation, as shown. Screw the cover onto the housing again (3).

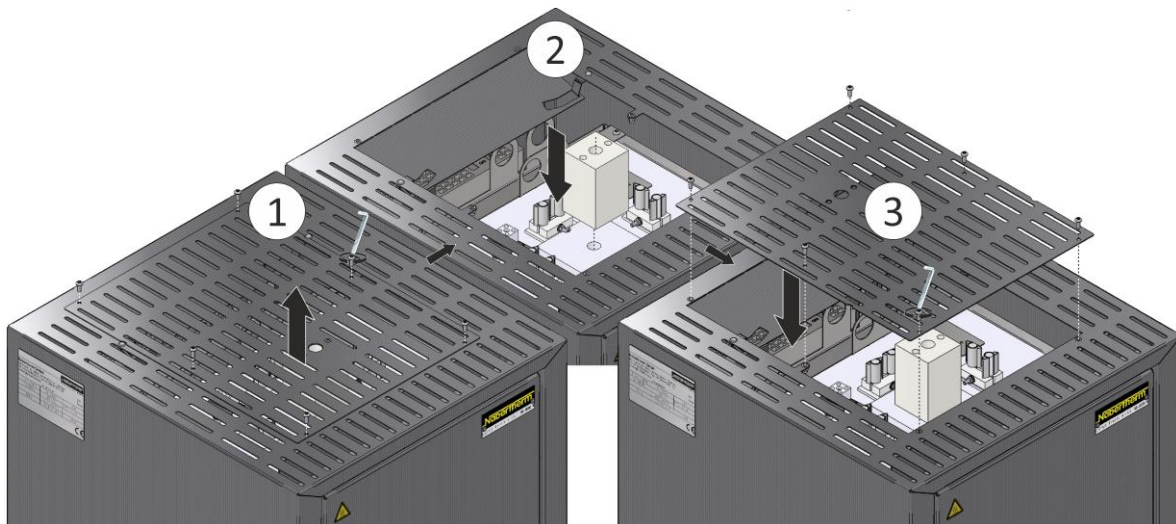

Undo the screws (1) from the protective metal sheet on the cover, using a suitable tool, and remove the sheet (2), which will be used later to secure the exhaust air tube.

Carefully slide the exhaust air tube (3) into the opening. The top of the exhaust air tube must sit on the furnace cover. Reinstall the protective metal sheet (4) of the exhaust air tube with the screws (5) that were previously removed.

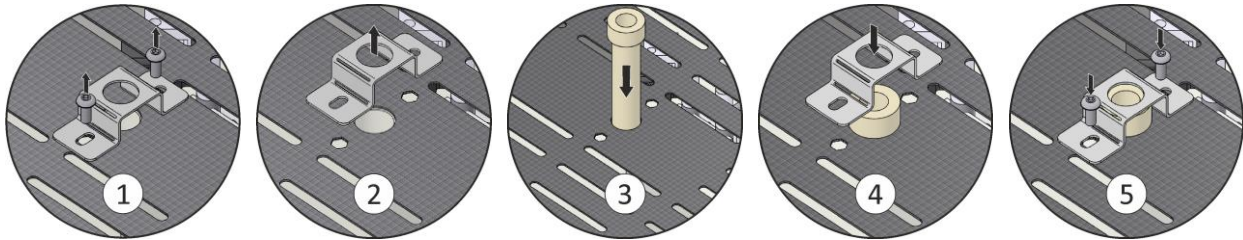

### Inserting the base plate

Carefully place the base plate in the center of the furnace floor, making sure that you do not damage the door collar. Avoid contact with the heating elements, as they could be damaged. If possible, position the charge in the center of the base plate. This ensures even heating. Once the furnace has been charged, carefully close the furnace door.

**Do not exceed the maximum load of the furnace floor of 2 kg/dm<sup>2</sup> and do not use more than one base plate.**

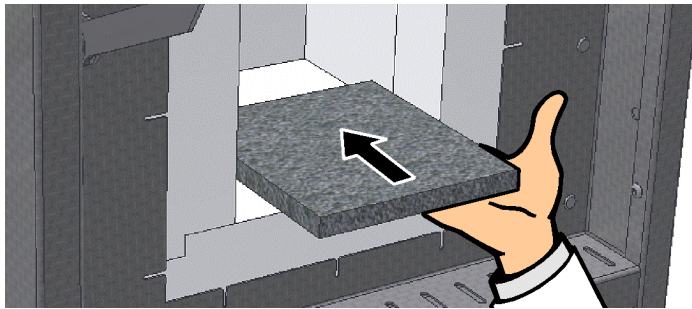

## 9 Venting Exhaust Fumes

We recommend that you connect a pipe to the furnace to remove the exhaust gases.

A suitable metal exhaust gas pipe of NW 80 to NW 120 can be used to vent the gases. It must be attached facing upwards and be fixed to the wall or ceiling. Position the pipe in the middle above the exhaust tube of the furnace.

The exhaust gas pipe must not be fitted tightly to the exhaust tube, otherwise there will be no bypass effect. This is necessary so that not too much fresh air is drawn through the furnace.

We recommend that you remove the exhaust air with a flue.

## 10 Connecting the furnace to the power supply

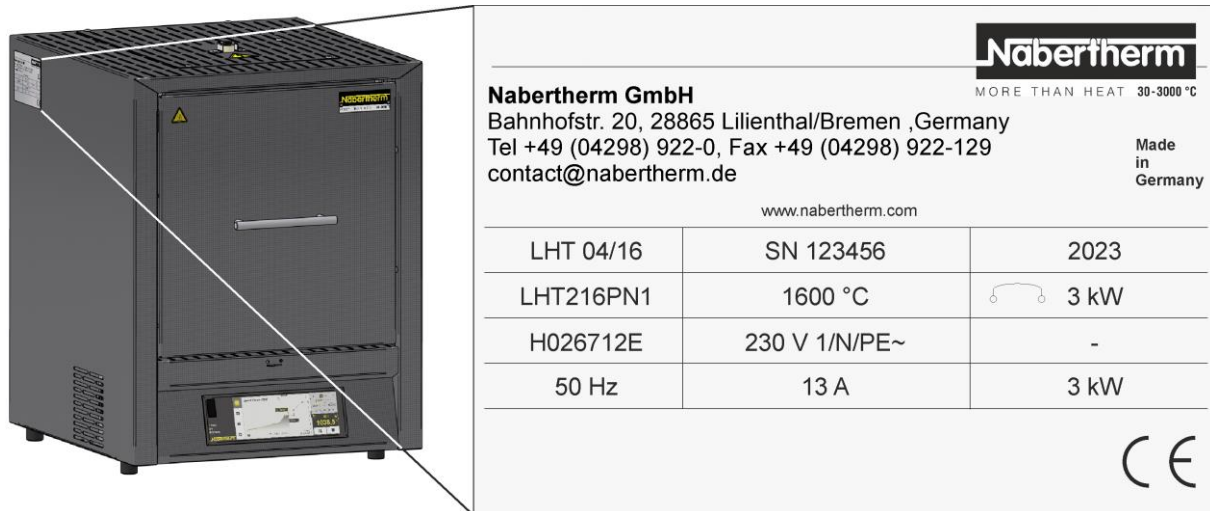

The customer must provide the electrical power supply.

- The furnace must be installed according to its intended use. The power connection must correspond to the values on the furnace type plate.
- The power socket must be close to the furnace and be easily accessible.
- Do not use extension cables or power strips.
- The power cable must not be damaged. Do not place any objects on the power cable. Lay the cable in such a way that no one can stand on it or trip over it.
- Power cables may be replaced only with similar, approved cables.
- Ensure that the connection cable of the furnace is protected.

Plug the supplied power cable with snap-in coupling (not available with 3-phase connections) into the rear wall or side of the furnace. Then connect the power cable to the power supply. Use only an electric socket with suitable protective ground contact. Connect the power cable to the power supply. Testing of ground resistance (compliant with VDE 0100); also refer to the accident prevention regulations.

### Power cable with plug:

Insert the plug into a suitable electric socket with a separate power supply and fuse. Pay attention to the information on the type plate as regards voltage, supply type and max. power consumption. The distance between the furnace and the socket should be as short as possible. Do not use extension cables or power strips. Have an electrician check the building wiring and electric socket before connecting the furnace. With household electric plugs, a loose contact can cause burning.

The power plug must be accessible at all times when the furnace is operating so that it can be pulled out quickly in case of an emergency.

## 11 Initial Start-Up and Initial Heating

Before starting the furnace for the first time, allow it to acclimatize at its installation location for 24 hours.

When the furnace is put into operation, the following safety information must also be observed to prevent injuries and damage to property.

- Make sure that the instructions and information in the operating manual and the controller instructions are observed and followed.
- Before starting the furnace for the first time, make sure that all tools, parts that do not belong in the furnace and transportation securing equipment have been removed.
- Before you switch on the furnace, make sure that you know what to do in case of faults or emergencies.

Before placing materials in the furnace, check whether they could harm or destroy the insulation or the heating elements. Materials that could damage the insulation include: alkalis, alkaline earths, metal vapors, metal oxides,





chlorine compounds, phosphorous compounds, and halogens. **If applicable, read the labels and instructions on the packaging of materials that you use.**

Heat the furnace to dry out the insulation and to get a protective oxide coating on the heating elements. **The life of the heating elements is dependent on obtaining a good oxide coating.** Above 800 °C, a silicon oxide coating forms on the surface of the molybdenum disilicide heating elements, which protects the elements against further oxidation. At lower temperatures, this protective coating does not form. If the element surface is not protected, molybdenum and silicon can oxidize at temperatures around 550 °C. A yellow powder consisting mostly of molybdenum oxide (MoO<sub>3</sub>) forms. This chemical reaction has no adverse effects on the performance of the heating elements.

Heat the empty furnace **100 °C below the maximum temperature** (see type plate) **within 5 hours** and maintain this temperature for about 5 hours. After this initial heating phase, allow the furnace to cool to room temperature. The furnace is now ready for operation.

There may be some unpleasant odors while the furnace is heating. This is due to binder being emitted from the insulation material. It is advisable to ventilate the room in which the furnace is located well during the first heating phase.

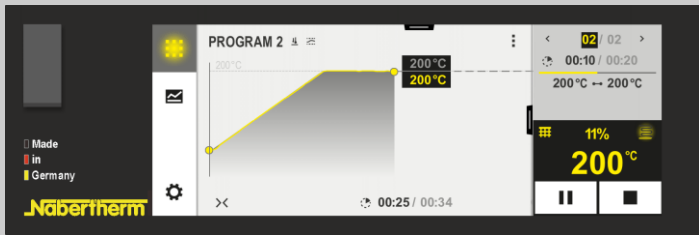
## 12 Operation

Switch on the controller		
		
Procedure	Display	Comments
Switch on the power switch		Set the power switch to "I". (Power switch type varies according to design/furnace model)
The furnace status is displayed. After a few seconds, the temperature is displayed. The first time you switch on the furnace, a wizard is displayed that enables you to enter some basic settings, such as language.		Once the temperature is shown on the controller, the controller is ready for operation.



### Note

See the separate operating instructions for a description of how to enter temperatures and times and to "start" the furnace.

## 13 What to do in case of an emergency

In case of unexpected events in the furnace (e.g., a lot of smoke, odors or fire), switch the furnace off immediately by disconnecting the power plug and keep the door and fresh-air lever closed. Wait until the furnace has cooled naturally to room temperature.

**The electric socket must be accessible at all times when the furnace is operating.**

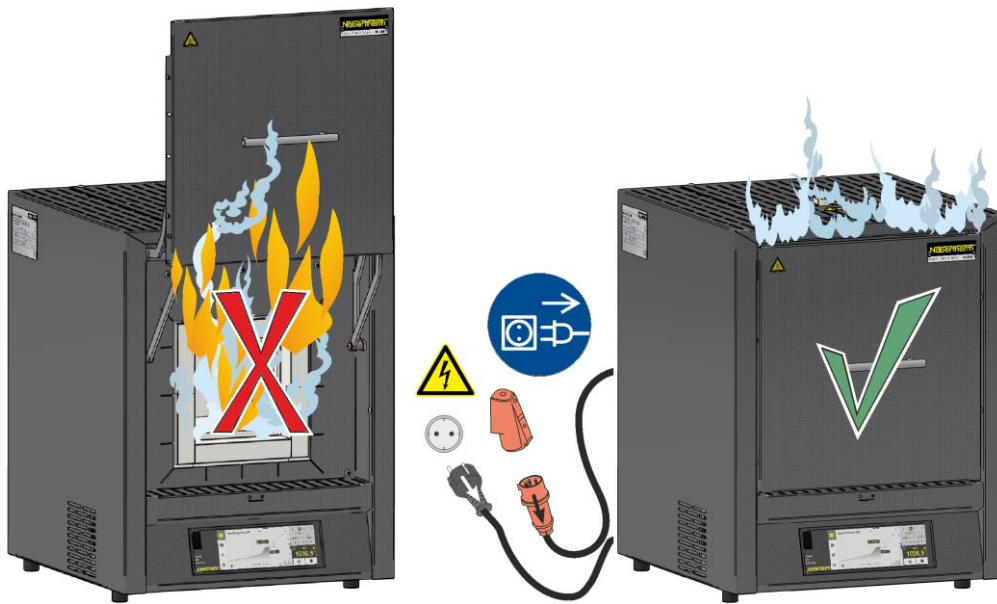

## 14 General Operation and Loading the Furnace

Operate the furnace only when all protective equipment and safety-related devices are present and functioning. Place only materials and substances whose properties are known in the furnace. Before starting the firing, clear the area around the furnace. Open and close the furnace door carefully. When loading the furnace, make sure that the door collar, the furnace insulation and the heating elements are not damaged. Avoid all contact with the heating elements. When the furnace has been loaded, close the door carefully so as not to damage the insulation. Make sure that the door is closed properly. To ensure even temperature distribution, leave space between the ware in the furnace and to the side walls.

Large quantities of material in the furnace can substantially lengthen the heating time.

If a crucible is being used, make sure that the material to be melted is placed in the crucible carefully. Crucibles are sensitive to impacts and knocks. When metal is heated, it expands faster and stronger than a crucible.

If it can be at all avoided, do not open the furnace when it is hot. We recommend that you leave the charge in the furnace until it is completely cooled.

Discoloration of stainless steel and cracks in the insulation/tiles caused by heat expansion have no effect whatsoever with regard to the functioning or quality of the furnace.

### Stackable saggars / sintering bowls (accessories)

Position the bottom sagger in the middle of the base plate and place up to three saggars and lids on top of it in the middle. When closing the furnace door, make sure that the door insulation does not push the sagger into the furnace chamber.

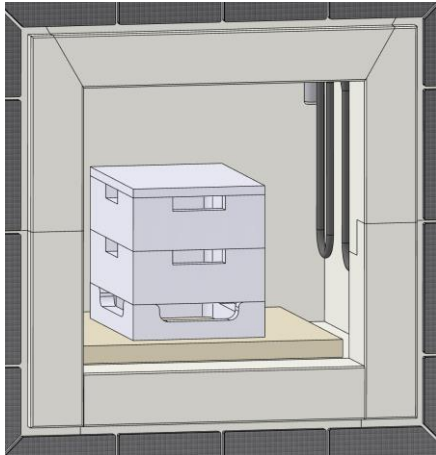

Sagger for  
LHT 02/16 – 08/18, LHT 01/17D

Position the spacer ring on the middle of the base plate and leave it in the furnace while charging to protect the floor. Place the sintering bowls on top of this and place an upside-down bowl on top as a lid. When closing the furnace door, make sure that the door insulation does not push the sagger into the furnace chamber.

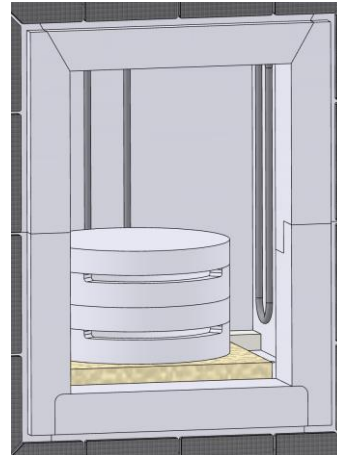

Sintering bowl for  
LHT 03/17D

## 15 Cleaning products

To clean the furnace, it is important that the power plug is pulled out and that the furnace has cooled completely. Pay attention to the labeling and information on the cleaning product packaging.

Use commercial cleaning products that are either water-based or non-flammable and free of any solvents to clean the housing. Use a vacuum cleaner for the interior.

Wipe the surface with a damp, lint-free cloth. You may also use the following cleaning products:

Component and position	Cleaning product
Outer surfaces (frame)*	Use commercial cleaning products that are either water-based or non-flammable and free of any solvent*
Outer surfaces (stainless steel)	Stainless steel cleaner
Interior	Carefully clean with a vacuum cleaner (pay attention to the heating elements)
Insulation materials	Carefully clean with a vacuum cleaner (pay attention to the heating elements)
Instrument panel	Wipe the surface with a damp, lint-free cloth (e.g., glass cleaner)

\*You must ensure that the cleaning product does not damage the water-soluble, environmentally safe paint (test the product on an interior, concealed area).

Clean quickly to protect the surfaces. Remove the cleaning product completely from the surfaces by wiping them with a damp, lint-free cloth.



MORE THAN HEAT 30-3000 °C

**Headquarters:**

Nabertherm GmbH · Bahnhofstr. 20 · 28865 Lilienthal/Bremen, Germany · Tel +49 (4298) 922-0, Fax -129 · [contact@nabertherm.de](mailto:contact@nabertherm.de) · [www.nabertherm.com](http://www.nabertherm.com)

Req: M01.1079K ENGLISCH